

Submersible Pumps

- **Cast Iron with Stainless Steel Motor Housing**
- **1/2 HP and 1 HP, 115 VAC, 60 HZ with 20 Foot Cord**
- **2" and 3" NPT Discharge Port with Hose Adapter**
- **Clog Resistant Impeller**
- **Continuous Duty with Automatic Thermal Overload Protection**
- **1/2 Horsepower Models**
 - ◆ **Heavy Duty Polypropylene Strainer**
 - ◆ **Ceramic/Carbon Mechanical Seal Plus Shaft Seal**
- **1 Horsepower Models**
 - ◆ **Stainless Steel Strainer**
 - ◆ **Dual Ceramic/Carbon Mechanical Seal Plus Shaft Seal**
- **Built-In Carry Handle for Portability**
- **UL/CSA Listed**



Model 5981-95

Model 598A-95

AMT Industrial Submersible pumps are lightweight, portable, reliable and energy efficient. The clog resistant impeller is designed for general dewatering pump use of which applications include: sump pumps, basements, construction drainage, dewatering, waste water treatments, agricultural irrigation, flooding and other applications requiring clear/drainage water removal. Motors are rated continuous duty 115VAC @ 60 Hz with standard cord/plug and have automatic thermal overload protection.

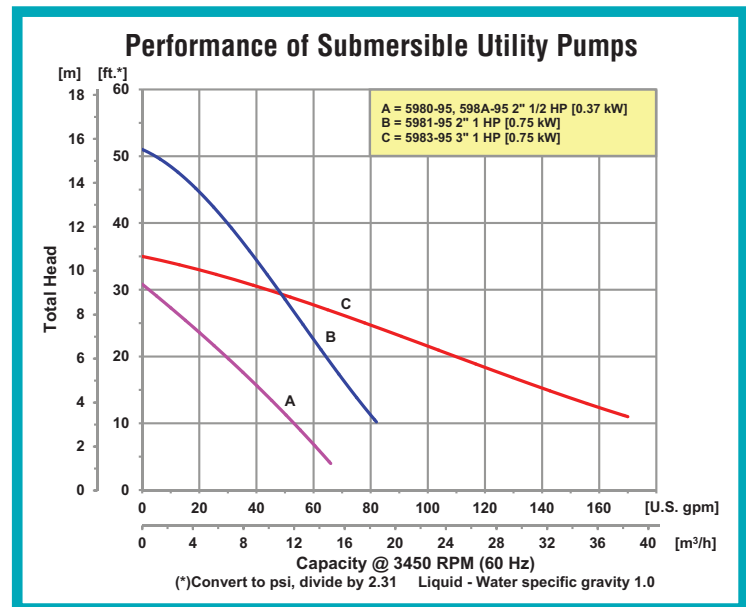

400 Spring Street • Royersford, PA 19468 USA

www.amtpump.com • 888-amt-pump (268-7867)

For use with nonflammable liquids compatible with pump component materials. Viton® is a registered trademark of E.I. DuPont.

Pump Dimensional & Specification Data

Model	Curve	DIS*	HP	PH	Voltage @ 60 Hz	Full Load Amps	Max Solids (Dia)	Cord Length (Ft.)	A	B	C [§]	D	W	H	Ship Wt. (Lbs.)
598A-95†	A	2	1/2	1	115	7.5	5/32	20' w/plug	4.2 [10.6]	5.7 [14.4]	5.0 [12.7]	3.8 [9.6]	8.3 [21.0]	15.0 [38.1]	24
5980-95															26
5981-95	B	3	1	1	115	13	7/32	20' w/plug	5.3 [13.4]	7.8 [19.8]	6.0 [15.3]	4.6 [11.7]	10.8 [27.4]	17.5 [44.5]	46
5983-95	C	3	1	1	115	13	7/32	20' w/plug	6.0 [15.3]	7.5 [19.1]	7.0 [17.8]	5.9 [15.0]	11.8 [29.9]	18.8 [47.7]	53

(*) Standard NPT (Female) Pipe Thread

(†) Automatic Float Switch

NOTE: Dimensions are in inches (centimeters) and have a tolerance of $\pm 1/8"$

(§) Minimum Liquid Height

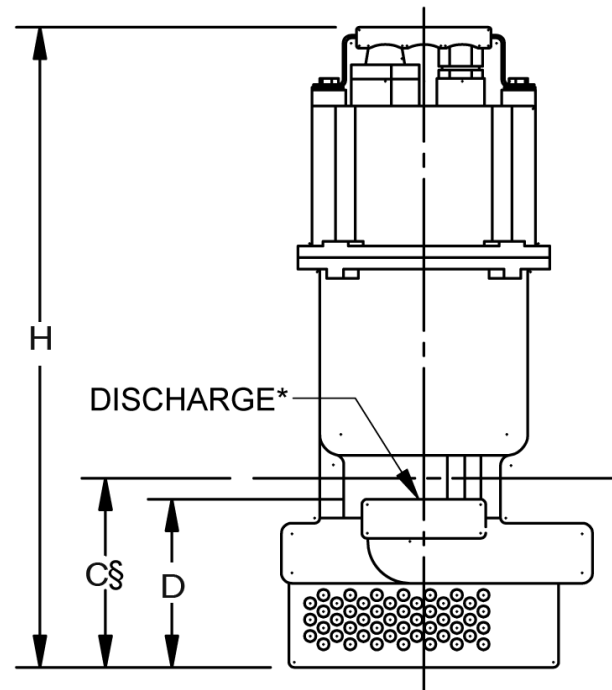
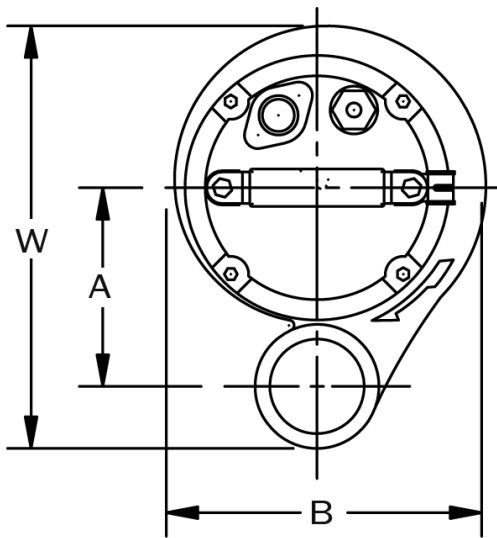

Standard Features

- Cast Iron Construction With Stainless Steel Housing
- Automatic Float Switch (Model 598A-95 only)
- Stainless Steel External Hardware
- Maximum Temp 104°F (40°C)
- Double Mechanical Seal Construction
- Built-In Carry Handle for Portability
- Suction Screen
- UL/CSA Listed
- QSP: Quick Ship Pumps